



**SINT**  
**Technology**

## ***MTS3000 - Restan***

---

***Automatic System for Residual Stress  
Measurement by Hole-Drilling***



## The MTS3000 - Restan system for measuring residual stresses

- Fully automatic drilling and acquisition process ensuring high repeatability
- High speed drilling (400,000 rpm).
- Automatic stepping motor control of drilling depth
- Automatic zero-depth detection
- Measurement of residual stress variation with the testing depth
- Choice of stress profile calculation methods
- Choice of residual stress calculation methods
- Fully compliant to the ASTM E837-08 standard
- High measuring accuracy

## Residual stresses and measurement by the hole-drilling method

All stresses that exist in materials without any external forces are called residual stresses. These stresses influence the behavior of mechanical components and can affect their structural and dimensional stability as well as the fatigue and fracture resistance of the materials. A residual tensile stress actually facilitates crack propagation and therefore reduces the fatigue life of a mechanical component. Residual stresses limit the loading capacity and safety of mechanical components during operation and in certain conditions it is necessary to know the quantity of those stresses.

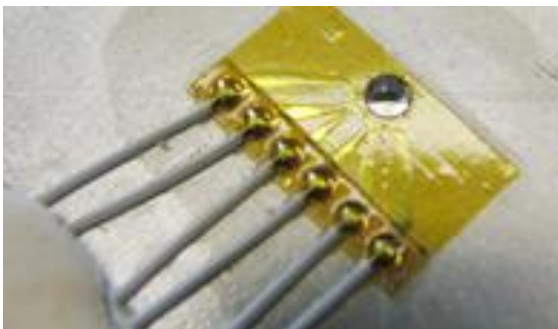

The hole-drilling method allows accurate experimental stress analyses at moderate costs. It consists in drilling a small hole (typically 1.8 – 2.0 mm) which changes the initial deformation allowing redistribution of residual stresses locked in a material.

The hole-drilling strain-gage method has been standardized by the ASTM E 837-08 "Standard Test Method for Determining Residual Stresses by the Hole-Drilling Strain-Gage Method".

## The MTS3000 system for measuring residual stresses

The MTS3000 or RESTAN (Residual Stress Analyzer) is an instrument designed for measuring residual stresses by the hole drilling method developed and patented by SINT Technology.

### The MTS3000 system consists of:

- An optical alignment system (to align the drilling axis to the rosette centre)
- An high speed air turbine drilling system (to physically make the hole)
- An electronic control unit (that controls the alignment-drilling system and the measurements by analog amplifiers)
- Hole drilling operating and control software (enabling /disabling the automatic drilling)
- Software to process the acquired data (allowing residual stress to be calculated and determined by different methods)



The heart of the system is the alignment-drilling unit, which is used to physically drill the hole and align the cutter with the center of the strain gage rosette by means of a cross reticule in the eyepiece. The system is also used, at the end of testing, to obtain the measurement of the hole diameter.

Movement on the horizontal x-y plane is made by micrometer adjustments. The magnetic feet and the overhung design allow the system to be positioned in any operating condition without any difficulty.

There are two types of vertical movements: a manual advancement of the drilling head by an adjustment knob, and a fine positioning automatically controlled with a stepping motor. With the latter type, all drilling steps can be made with a resolution of 1 $\mu$ m and feed rate from 0.03 to 1 mm/min. Zero depth detection is carried out automatically on conductive materials by an electrical contact system.



The operations that the user has to perform are:

- Install the strain gage rosette
- Position the drilling device over the center of the strain gage rosette
- Configure the test conditions for the hole drilling (RSM software)
- Determine hole eccentricity from the strain gage readings
- Process the data by the calculation software (EVAL software)

## MTS3000: drilling control and data acquisition software (RSM)

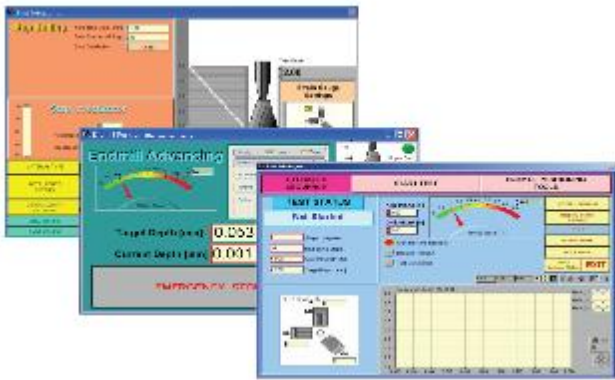

All hole drilling operations are performed automatically by the operating and control software (**SINT RSM**) following operator input, such as:

- Number of depth increments
- Distribution of depth increments (linear, polynomial or linear in sections)
- Drilling feed rate
- Acquisition system
- Type of rosette and rosette parameters
- Delay time before acquisition of strain measurements

## MTS3000: residual stress evaluation software (EVAL)

Acquired data can be processed using the SINT EVAL analysis software.

The calculation system uses the following methods:

- ASTM E 837-08 for uniform stresses
- ASTM E 837-08 for non-uniform stresses
- Integral Method
- Schwarz – Kockelmann Method
- HDM method

Any analysis requirements that may arise in residual stress evaluations can be met having these methods available: the SINT EVAL software is fully compliant to the ASTM E837-08 standard for hole drilling measurements.

The software makes it possible to make corrections due to hole-rosette eccentricity and to the effect of plasticity within the hole boundary.

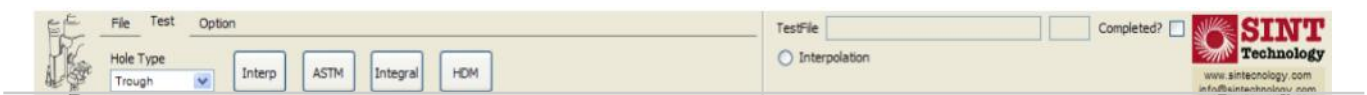
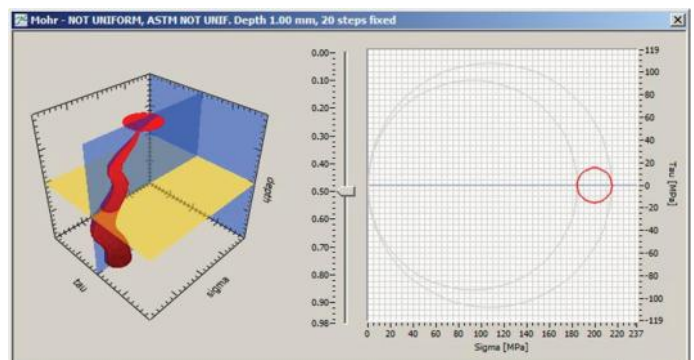
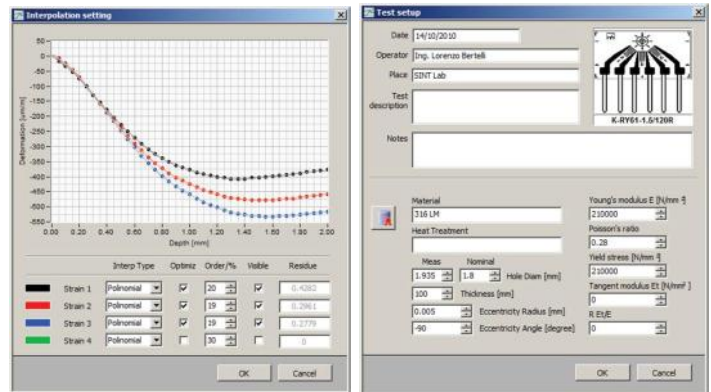

## Strain gage amplifiers

MTS3000 system can be used with digital strain gage amplifiers: in particular the HBM Spider 8, HBM Spider 8.30, HBM MGCplus and HBM QuantumX.

## PC minimum requirements

- Intel ATOM N570 1.66GHz, or equivalent (Intel Core i3 recommended)
- 1 GB Ram (4 GB recommended)
- 3 USB ports
- Windows 7 operating system

## Complete measurement chain

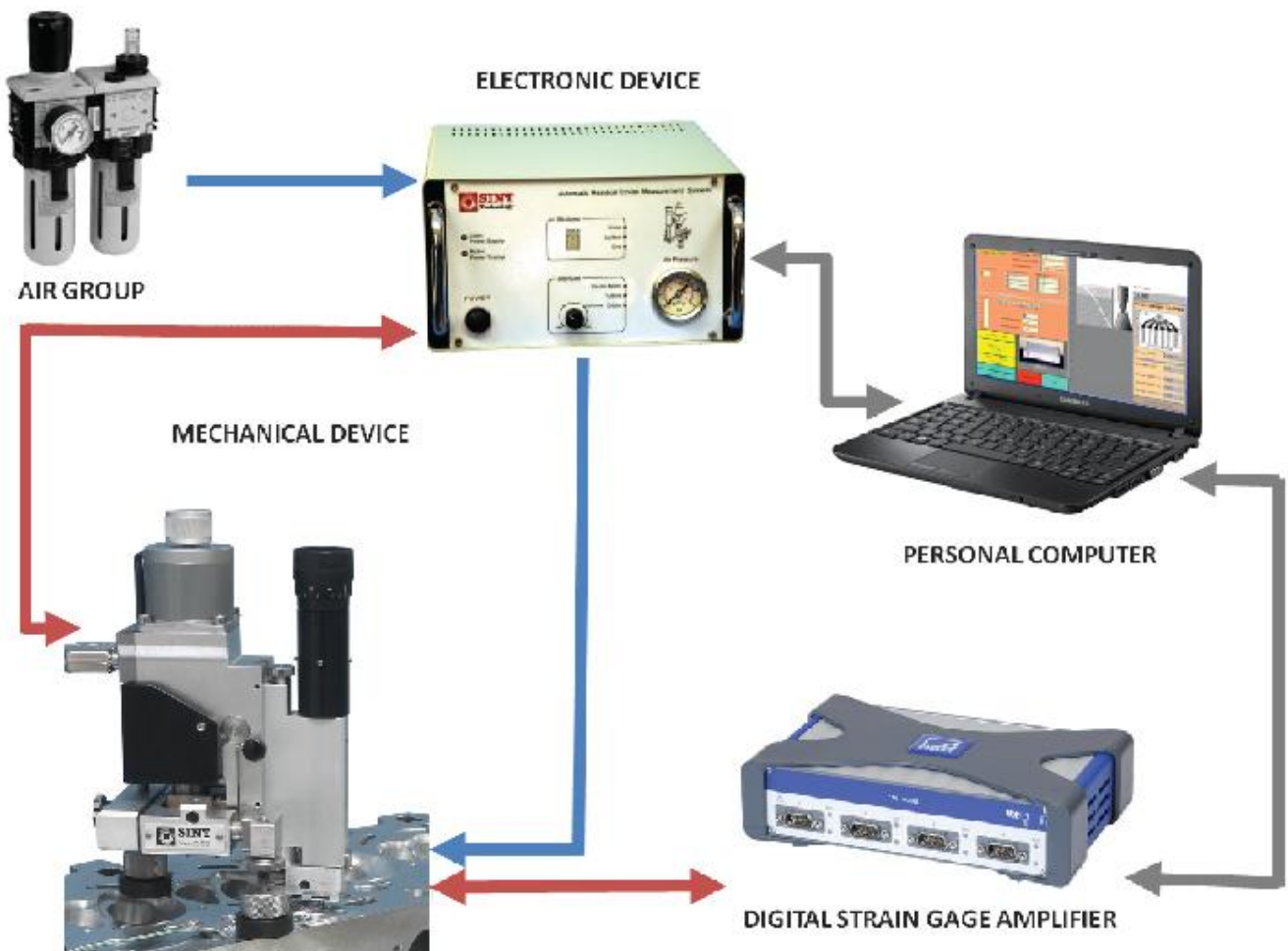

## Replacement and spare parts

The MTS3000 system offers a wide range of replacement and spare parts that increase the application field of the instrument: the special drills, developed for the system, allow the drilling process in a wide selection of materials (e.g. steel, aluminum, cast iron, inconel, titanium).

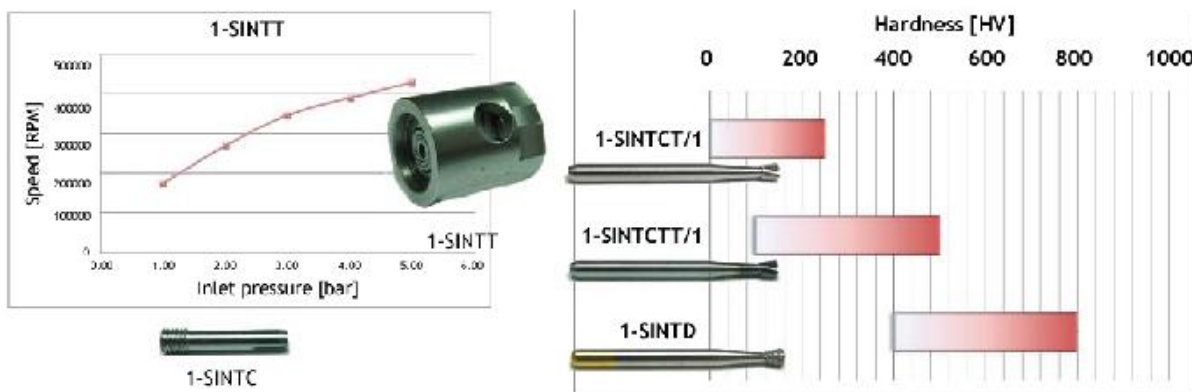

## Accessories and services

The MTS3000 system is equipped with a set of accessories that allow the instrument to be tailored to a wide range of requirements. Special solutions and configurations, such as supports, special magnetic feet, manual system, version for drilling inside pipes and drilling slide for polymeric materials, can also be designed to customer specifications.



SINT Technology also offers training courses on residual stress measurement using the MTS3000 system: SINT Technology is ISO/IEC 17025 accredited lab for the hole drilling method (ASTM E837-08).

## Technical specifications of the MTS3000 system: alignment-drilling tool

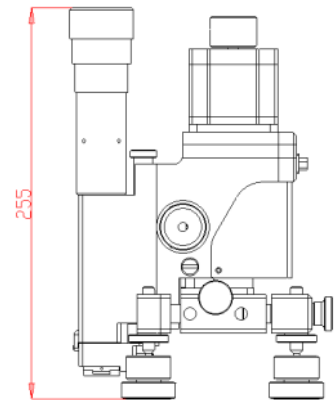
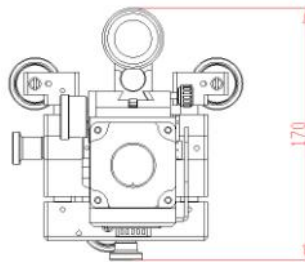
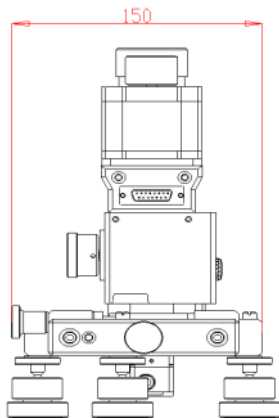

Dimensions (height, width and length) without dial gages	mm	270 x160x175
Weight	kg	4.6
Maximum turbine speed	RPM	400,000
Acoustic emission (at 1 meter)	dBa	76
Max turbine feed pressure	bar	5
Drilling resolution	µm	5
Drilling speed range	mm/min	0.03 to 1
Vertical lift (fast/manual)	mm	60
Vertical lift (slow with motor)	mm	6
Horizontal movement (x;y)	mm	7 -10
Height adjustment of feet	mm	60

## Technical specifications of the MTS3000 system: electronic control system

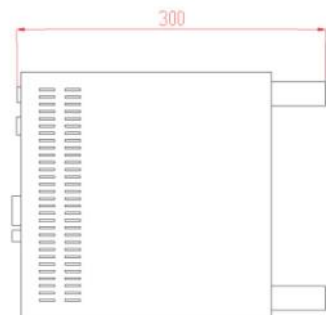
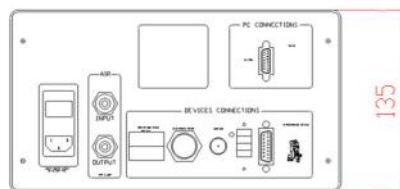
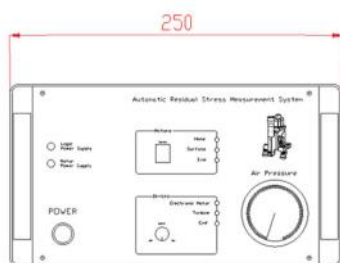

Dimensions (height, width and length)	mm	140 x 245 x 220
Weight	kg	5.4
Grid power supply	Vac	90 - 264 (50 - 60Hz)
Compressed air max. input pressure	bar	6



**SINT**  
**Technology**

### Contact us

Via delle Calandre, 63 - 50041 Calenzano (FI) ITALY

Tel: +39.055.8826302

Fax: +39.055.8826303

[www.sintechnology.com](http://www.sintechnology.com)

[info@sintechnology.com](mailto:info@sintechnology.com)

VAT n. 04185870484

### Recognitions

SINT Technology's test laboratory is accredited to standard ISO/IEC 17025:2005 by the Italian accreditation body **ACCREDIA** with **certificate no. 0910**



LAB N° 0910

Certification of conformity to the requirements of standard

**UNI EN ISO 9001**

